

HD-DV Camcorder

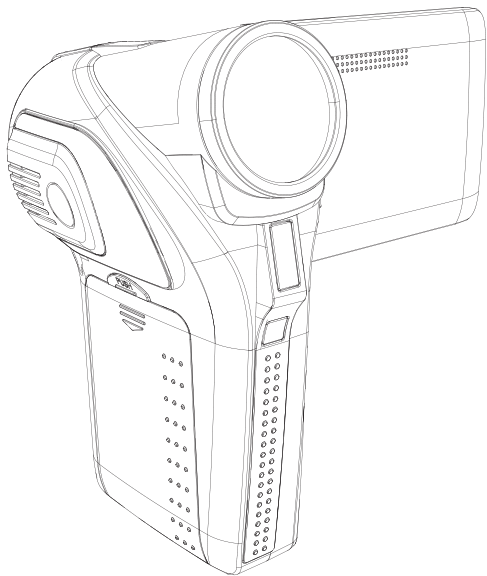

Welcome:

Dear user, thanks for purchasing this product.

Much investment in time and effort has gone into its development, and it is our hope that it will give you many years of trouble-free service.

Safety Notice:

1. Do not drop, puncture or disassemble the camera; otherwise the warranty will be voided.
2. Avoid all contact with water, and dry hands before using.
3. Do not expose the camera to high temperature or leave it in direct sunlight. Doing so may damage the camera.
4. Use the camera with care. Avoid pressing hard on the camera body.
5. For your own safety, avoid using the camera when there is a storm or lightning.
6. Do not use batteries of different specifications. Doing so may lead to the potential for serious damage.
7. Remove the battery during long periods between usage, as a deteriorated battery may affect the functionality of the camera.
8. Remove the battery if it shows signs of leaking or distortion.
9. Use only the accessories supplied by the manufacturer.
10. Keep the camera out of the reach of infants.
11. Risk of explosion if battery is replaced by an incorrect type.
12. Dispose of used batteries according to the instructions.

FCC Compliance Statement:

This device complies with Part 15 of the FCC Rules. Operation is subjected to the following two conditions: (1) this device may not cause harmful interference, and (2) this device must accept any interference received, including interference that may cause undesired operation.



This equipment has been tested and found to comply with limits for a Class B digital device, pursuant to Part 15 of the FCC rules. These limits are designed to provide reasonable protection against harmful interference in residential installations. This equipment generates, uses, and can radiate radio frequency energy, and if not installed and used in accordance with the instructions, may cause harmful interference to radio communications.

However, there is no guarantee that interference will not occur in a particular installation. If this equipment does cause interference to radio or television equipment reception, which can be determined by turning the equipment off and on, the user is encouraged to try to correct the interference by one or more of the following measures:

- Reorient or relocate the receiving antenna.
- Move the equipment away from the receiver.
- Plug the equipment into an outlet on a circuit different from that to which the receiver is connected.
- Consult the dealer or an experienced radio/television technician for additional suggestions.

You are cautioned that any change or modifications to the equipment not expressly approved by the party responsible for compliance could void Your authority to operate such equipment.



If the time arises to throw away your product, please recycle all the components possible.

Batteries and rechargeable batteries are not to be disposed in your domestic waste! Please recycle them at your local recycling point.

Together we can help to protect the environment.

Table of Contents

Getting Started	1
Knowing your camcorder parts.....	1
Installing the battery.....	2
Charging the battery.....	2
Inserting a memory card (optional).....	2
Turning on/off your camcorder.....	2
Setting language.....	3
Reading LCD indicators.....	3
Basic Operations	4
Recording a video clip.....	4
Recording a voice clip.....	4
Taking a still picture.....	5
Playing back your recordings.....	6
Playing back your recordings on PC.....	7
Connecting the camcorder to TV.....	8
Advanced Operations	10
Menu operation.....	10
Menu items in Camera mode.....	10
Menu items in Playback mode.....	11
Menu items in Setting mode.....	12
Battery Life Indicator.....	13
Battery Life.....	13
Storage Capacity.....	14
System Requirements.....	14
Specifications.....	15

Getting Started

Knowing your camcorder parts

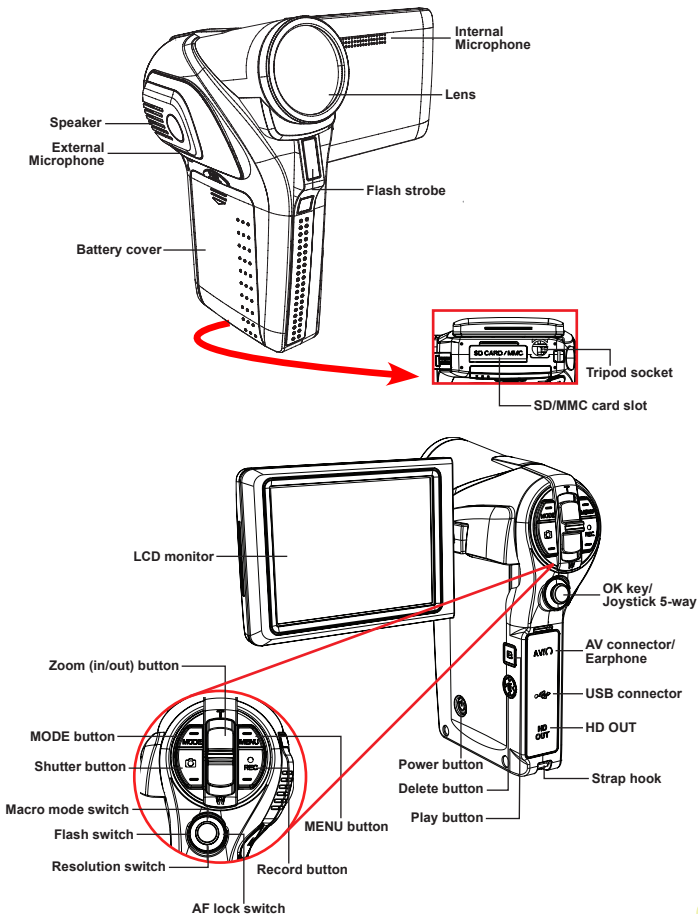

● Installing the battery

1. Press the **Push** button first and slide the battery cover open.
2. Place the accessory Li-Ion battery into the compartment. Note that the metallic contacts must be aligned with the contacts in the compartment.
3. After the battery is properly installed, replace the battery cover.



● Charging the battery

Please charge the battery at least 8 hours for first time use.

1. Connect the cable.
Connect one end of the supplied AC adapter to the USB port of the camcorder and the other end to a wall outlet.
OR
Connect one end of the supplied USB cable to the USB port of the camcorder and the other end to a powered PC. Make sure the camcorder is powered off.
2. The charging LED turns red and the charge starts.
3. When the charging is interrupted or the battery pack is fully charged, the charging LED will turn green.



❗ When using a PC to charge the battery, do not power on the camcorder, or the charge will stop.

● Inserting a memory card (optional)

To insert a memory card, do the followings:

- (1) Open the SD/MMC card cover.
- (2) Gently push the card until the card reaches the bottom of the slot.

To remove the memory card, gently push the card and it will pop up. Then pull the card out of the slot.

● Turning on/off your camcorder

Open the LCD monitor or press and hold down the **Power** button for 1 second to turn on the camcorder.

To turn off the camcorder, press and hold down the **Power** button for 1 ~ 3 seconds or close the LCD monitor.

❗ If the camcorder stays inactive for a long period of time, it may automatically shut down due to the Auto-Off setting.

● Setting language

1. Power on the camcorder.
2. Press the **MODE** key to enter the **MODE** menu.
3. Use the **Joystick** switch to select the **Setting** mode and press **OK** to enter the menu screen.
4. Use the **Joystick** to select the **Language** item, and then Press **OK** to confirm.
5. Move the **Joystick** up/down to select a language.
6. When done, press **OK** to confirm the setting.

● Reading LCD indicators

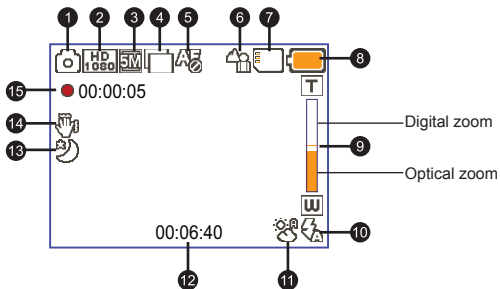

- | | |
|------------------------------------|------------------------------|
| 1 Mode icon | 9 Zoom ratio indicator |
| 2 Video resolution | 10 Flash |
| 3 Picture resolution | 11 White balance |
| 4 Continuous shot | 12 Remaining recordable time |
| 5 AF lock | 13 NightShot |
| 6 Focus | 14 Stabilizer |
| 7 Internal memory/SD card inserted | 15 Recording time |
| 8 Battery life | |

Basic Operations

● Recording a video clip

1. Adjust the focus:
Normally the camcorder can auto focus without adjusting focus. If you want to take close-up pictures, you can push the Up button to switch to Macro mode (♥).
2. Zooming:
Move the **Zoom** button up or down to zoom in or zoom out the screen.
3. Press the **Record** button to start recording.
4. Press the **Record** button again to stop recording.

- ❗ The zoom function is also available during recording (except in macro mode).
- ❗ The camcorder has built-in electronic stabilizer, which can only be activated in HD 720P(60f) / WVGA(60f). In HD 1080P(30f) mode, this function is disabled.
- ❗ It's normal that the camcorder will feel slightly warm with continuous use / recording due to its high performance.

▶ AF lock

When recording in one spot without zooming in / zooming out or moving around, you can activate the AF lock function by moving the **Joystick** right. To disable this function, move the **Joystick** right again.

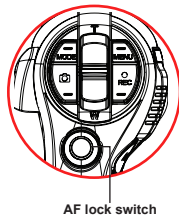

● Recording a voice clip





1. Power on the camcorder.
2. Press the **MODE** key to enter the **MODE** menu.
3. Use the **Joystick** switch to select the **Voice Recorder** mode and press **OK** to enter the menu screen.
4. Press the **Record** button to start recording
5. Press the **Record** button again to stop recording.

● Taking a still picture

1. Adjust the focus:
Normally the camcorder can auto focus without adjusting focus. If you want to take close-up pictures, you can push the Up button to switch to Macro mode (🍀).
2. Zooming:
Move the **Zoom** button up or down to zoom in or zoom out the screen.
3. Press the **Shutter** button half way down and hold for the camcorder to auto focus. When the focus frame turns green, press the button fully down to take a still picture.

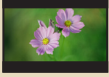

❗ Due to the sensor capture feature, the LCD preview and ratio of still picture capture will vary depending upon different video resolution settings. The image capture of the camera is set where as video resolutions are different.

Video resolution	Preview	Taking pictures and focusing
HD 1080P(1440x1080)	16:9 ratio 	4:3 ratio 
HD 60f(1280x720)	16:9 ratio 	4:3 ratio 
WVGA 60f(848x480)		

▶ Continuous shot

While in preview mode you can capture continuous images (at video resolution) by “clicking and holding down” the **Joystick**. The camcorder will continuously snap shots (up to 10 per second) until you release the **Joystick**, or until the memory is full.

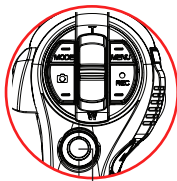

❗ Continuous shot function is disabled in HD 1080P(30f) mode.



OK key / Joystick 5-way

● Playing back your recordings

1. Press the **MODE** button and use the **Joystick** to switch to “**My Works**” mode.
Or press the **Play/Pause** button (▶) on the left side of the LCD monitor.
2. There are three folders below **My works: Video, Picture, and Voice**. Select Video, Picture or Voice, and then press the **OK** key to enter the index mode.
3. Operations in playback mode:

File type	How to...	Action
Index mode 	Shift between Index mode and Full-screen mode	In Index mode, press the OK key to switch to Full-screen mode. In Full-screen mode, press the MENU button to switch to Index mode.
Full-screen mode 	Shift between files	1. In Index mode: Use the Joystick to move the highlight box. 2. In Full-screen mode: Use the Joystick to move left or right.
Video & Audio	Start playing	When selected (in full-screen mode), the file automatically starts playing.
	Pause/Resume playing	During playing/While paused, press the OK key.
	Adjust the volume level	During playing, use the Joystick to move up or down.
	Stop playing	During playing, press the MODE button.
	Return to the preview screen	Press the Shutter button.
	Fast forward	During playing, use the Joystick to move right. To stop, press the OK key.
	Fast backward	During playing, use the Joystick to move left. To stop, press the OK key.
Picture	Zoom in/out	Use the Joystick to move up or down.
	Lock/Release zoom ratio	When the zoom ratio is greater than 1.0x, press the OK key.
	Browse the enlarged picture	When the zoom ratio is locked, use the Joystick to browse the picture.

● Playing back your recordings on PC

▶ Installing software

Please notice that the recorded videos are .mov format. So you need some special programs to view the recordings on PC. For first time use, please make sure you have QuickTime 7.0 (or above) player on your PC. If not, please download the QuickTime player from the website.

OR

Please install the software on the bundled CD.

▶ Connecting to PC and Saving files

After the software is properly installed on your PC, please follow the procedures listed below.

1. Turn on the camcorder.
2. Connect the camcorder (with SD card inserted) to your computer with the USB cable.
3. A dialogue window will appear automatically. Please select the item "**Open folder to view files**" and click "**OK**".
4. If the dialogue window does not appear automatically, you may double click on "My computer" and open the "Removable Drive".
5. Double-click on the **DCIM** file folder.
6. Double-click on the **100MEDIA** file folder.
7. Copy the files you wish to keep and save them to the desired location on your computer.

● Connecting the camcorder to TV

Please follow the below instructions to connect your camcorder and TV via accessory AV cables for real-time display. You can display your video clips and still pictures on your TV, sharing them with your friends and family.

▣ Connecting the camcorder to HDTV

HD TV hereby means the HDTV built-in component input ports, thus can perform HD high resolution quality while connected.

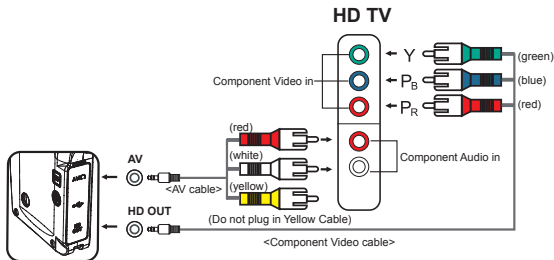

1. Turn on your HD TV.
2. Turn on the Camcorder.
3. Plug one end of the component video cable into the (Component Video IN) port on the HDTV and the other end into the (HD OUT) port on the Camcorder.
4. Plug one end of the other AV cable into the (Component Audio IN) port on the HDTV and the other end into the (AV) port on the Camcorder. (Please do not plug in the yellow connector to the HDTV's AV-IN.)
5. Press the input switch mode on the HDTV and select "Component Input".

❗ If you record an HD resolution clip while connected to your HD TV, the TV display video resolution will down size to WVGA resolution due to data bit rate, but the recorded file will remain HD with no change.

❗ The HD TV will display your video clips in 1080i (60 fields) resolution mode although it is recorded in 1080P (30 frames) setting.

▶ Connecting the camcorder to Standard TV

TV = Traditional CRT TV

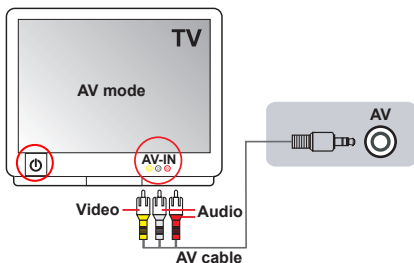

1. Power on your TV and switch the TV to AV mode.
2. Connect the audio and video ends of the AV cable (yellow/white/red color) to the TV "AV-IN" jacks.
3. Power on the camcorder.
4. Connect the other end of the AV cable to the "AV" port on your camcorder. When the pop-up message appears on the screen, please select "AV-Out".

Advanced Operations

● Menu operation

The menu items provide several options for you to fine-tune your camera functions. The following table gives details on menu operations.

How to...	Action
Bring up the menu	Press the MENU button.
Move the highlight bar	Use the Joystick to move up or down.
Enter sub-menu/Confirm an item	Press the OK key.
Exit menu/Go back to upper menu	Press the MENU button (when in sub-menu).

● Menu items in Camera mode

Power-on → Press the **Menu** button.

Item	Option	Description
Video Resolution	HD 1080P(30f)	Set the video resolution to HD 1080P (1440x1080 pixels).
	HD 60f(720P)	Set the video resolution to HD 60f (1280x720 pixels).
	WVGA 60f(DVD)	Set the video resolution to WVGA 60f (848x480 pixels).
Flash Strobe	On	The flash is forced to fire in every shot.
	Auto	The flash automatically fires when the lighting is insufficient.
	Off	The flash is disabled.
NightShot	On/Off	Enabling this setting allows you to take a photograph with a dark background. Since the shutter speed will slow down when taking photographs at a dark place, we recommend using a tripod to eliminate blurring from hand shake. Warning: Noise increases when NightShot is enabled. Warning: The stabilizer function is disabled when NightShot is enabled.
EV	-2~+2	Enabling this setting allows you to take a photograph with a dark background. Since the shutter speed will slow down when taking photographs at a dark place, we recommend using a tripod to eliminate blurring from hand shake. Warning: Noise increases when NightShot is enabled.
Selftimer	On/Off	Enable/Disable the selftimer. After the selftimer is turned on, the camera will have ten seconds delay before recording when the Shutter button is pressed.

● Menu items in Camera mode (continued)

Item	Option	Description
Continuous Shot (at video resolution)	On/Off	Enable/Disable continuous shot function.
White Balance	Auto	The camera automatically adjusts white balance.
	Sunny	This setting is suitable for outdoor recording in sunny weather.
	Cloudy	This setting is suitable for recording in cloudy weather or shady environments.
	Fluorescent	This setting is suitable for indoor recording with fluorescent lamp lighting, or environments with high color temperature.
	Tungsten	This setting is suitable for indoor recording with incandescent lamp lighting, or environments with low color temperature.
Effect	Normal	Make recordings in natural color.
	Black & White	Make recordings in black and white.
	Classic	Make recordings in sepia-toned color.
AF Lock	On/Off	Enable/Disable auto focus function.
Stabilizer	On/Off	Enable/Disable stabilizer function. Stabilizer function can prevent the image from blurring causing by hand shake.

● Menu items in Playback mode

Power-on → Press the **MODE** button → Use the Joystick to switch to **My Works** mode → Select **Video, Picture** or **Voice** folder → Press the **OK** button → Press the **MENU** button.

Item	Option	Description
Delete One	Yes/No	Delete current file.
Delete All	Yes/No	Delete all pictures and video/audio files stored in the memory.
Lock	Yes/No	Single, multiple, or all files can be locked. A locked file cannot be erased by a delete function. While the formatting function will erase all locked/unlocked files.
Repeat All	All	The camera displays images/video clips in sequence. You can press the OK key to stop the slide show/video play.

* If there are no files in the camera, no items will be seen.

● Menu items in Setting mode

Power-on → Press the **MODE** button → Select the **Setting** () mode → Press the **OK** button.





Item	Option	Description
Clock	-	Set date and time.
Language	-	Let you select the language used for OSD.
Beep	Off	Disable beep sound.
	On	Enable beep sound.
	Shutter On	Disable beep sound, but keep Shutter sound.
Start Movie	On/Off	Enable/Disable start movie function.
Icon	On/Off	Enable/Disable OSD icons to display on the screen.
LCD Brightness	-2~+2	Set LCD brightness. A positive value makes the LCD brighter; while a negative value makes the LCD dimmer.
TV System	NTSC	Set TV system compatibility to NTSC. This option is suitable for America, Taiwan, Japan, and Korea areas.
	PAL	Set TV system compatibility to PAL. This option is suitable for Germany, England, Italy, Netherlands, China, Japan, and Hong Kong.
Flicker	50Hz	Set flicker frequency to 50Hz*.
	60Hz	Set flicker frequency to 60Hz*.
Auto Off	Off	Disable Auto-off function.
	1 min	The camera automatically shuts down when staying inactive for over 1 minute.
	3 min	The camera automatically shuts down when staying inactive for over 3 minutes.
	5 min	The camera automatically shuts down when staying inactive for over 5 minutes.
Format	Yes	Format the storage medium. Note that all files stored in the medium will be gone.
	No	Cancel action.
Default	On	Restore factory defaults. Note that your current settings will be overridden.
	Off	Cancel action.

● Menu items in Setting mode (continued)

* Flicker settings table:

Region	England	Germany	France	Italy	Spain	Netherlands	Russia
Setting	50Hz	50Hz	50Hz	50Hz	50Hz	50Hz	50Hz
Region	Portugal	America	Taiwan	China	Japan	Korea	Thailand
Setting	50Hz	60Hz	60Hz	50Hz	50/60Hz	60Hz	50Hz

● Battery Life Indicator

Icon	Description
	Full battery life
	Moderate battery life
	Low battery life * The flash strobe and the LED lights will be disabled."
	Empty battery life

Note: To avoid sudden outage of power supply, you are recommended to replace the battery when the icon indicates low battery life.

● Battery Life

Still picture	Video clip
Number of shots	Recording time (minute)
110	50
* shoot every 30 seconds ** flash is off *** resolution is set to 5M (2592x1944)	* resolution is set to 720P 60f (1080x720 @60f)

Note: This table is for your reference only. The actual battery life depends on your battery type and recharge level.

● Storage Capacity

Memory	Video (min.)		Still picture
	HD 1080P 30f / HD 720P 60f	WVGA 60f	5M
SD card (256MB)	3	7	145
SD card (512MB)	7	15	290
SD card (1GB)	15	30	580
SD card (2GB)	30	60	1160
SD card (4GB)	60	120	2320

Note: The actual value of capacity may vary (up to $\pm 30\%$) depending on the color saturation and complexity of your subject and surroundings.

● System Requirements



System requirements are different in different video resolution settings:

Video Resolution	PC system requirements
HD 1080P (1440x1080) @30fps	OS = Windows XP SP2, Vista or above CPU = Pentium 4 3.2GHz Core 2 Dual or above
HD 60f (1280x720) @60fps	System RAM = 1GB (2GB recommended) Graphic card = 256MB of RAM
WVGA 60f (848x480) @60fps	OS = Windows XP SP2, Vista or above CPU = Pentium 4 3.2GHz or above System RAM = 512MB (1GB recommended) Graphic card = 256MB of RAM

● Specifications

Item	Description
Model	5 Mega-pixel camera
Image sensor	5 Mega (2592x1944 pixels)
Resolution	Still image: 5M(2592x1944) 1440x1080 (HD 1080P) 1280x720 (HD 60f) 848x480 (WVGA 60f)
Lens	Optical zoom lens
Digital zoom	4X (2X in 1080P mode)
File format	MOV, JPEG, WAV
Video frame rate	1440x1080, up to 30fps (HD 1080P) 1280x720, up to 60fps (HD 60f) 848x480, up to 60fps (WVGA 60f)
Internal memory	Yes
External memory	SD/MMC card (up to 32GB SDHC)
LCD display	3" LCD
TV out	HDTV Component out, NTSC/PAL system supported
Interface	USB 2.0
Voice recorder	Yes
Microphone	internal (stereo); external mic jack
Speaker	Yes
Nightshot	Yes (both in still image and video modes)
E.I.S.	Electronic Image Stabilization (Only available in 720P 60fps and WVGA 60 fps, the video resolution mode)
Battery	NP60 compatible Li-ion rechargeable battery

Note: Specifications are subject to change without notification.

! For more information on camcorder details and more advanced operations, please refer to the electronic manual included in the accessory CD.

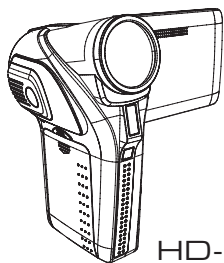

HD-DV Camcorder